

# 507 Post Specifications

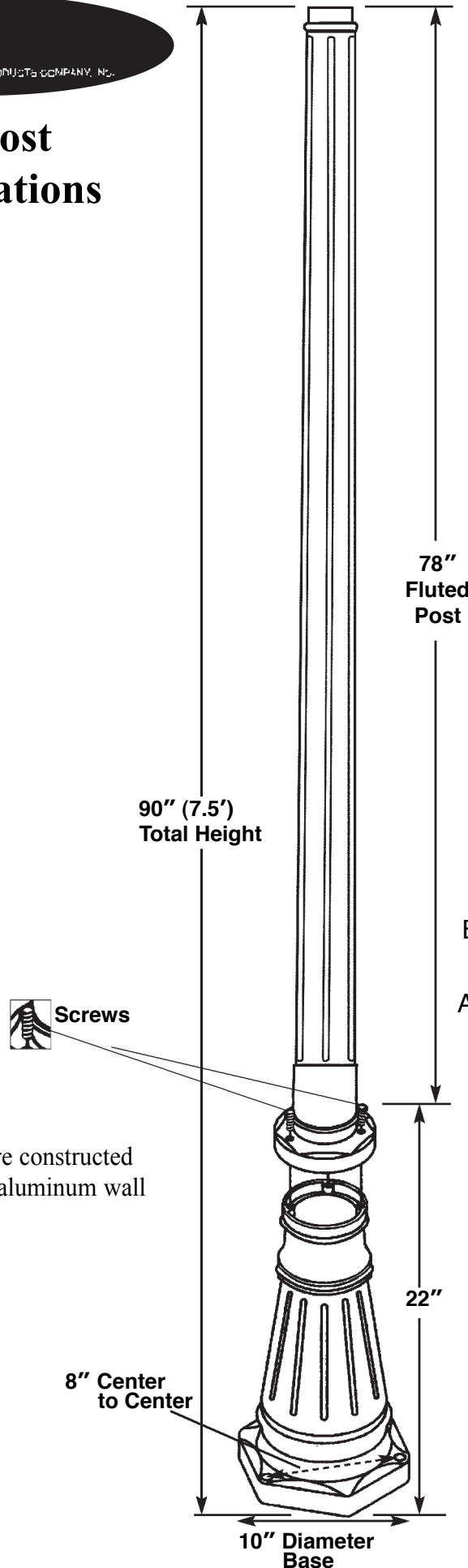

Special Lite posts are constructed of a minimum .075 aluminum wall thickness.

## ALL SURFACE MOUNTED POSTS COME COMPLETE WITH ANCHOR BOLTS AND TEMPLATE

### Installation:

The depth of this base will depend on local soil conditions and frost lines. The concrete base should be 12"/ 305mm diameter in order to hold the anchor bolts on the plate. Take the three anchor bolts (A) and run a nut (B) fully down each part of the thread section. Insert the anchor bolts into the straps (C) to make a triangle and secure with a second nut.(B)

1. Mix and pour the concrete into the former until it reaches the top. Push the assembly into the concrete until the plates are level with the concrete. Gently tap the side of the former to make sure the anchor bolts are fully surrounded by the concrete.

2. At this time it is very important to level the straps before the concrete sets. Place a level across the metal straps in several locations to ensure they are level.

3. Once the concrete is set, the top 3 nuts and straps may be removed.

